

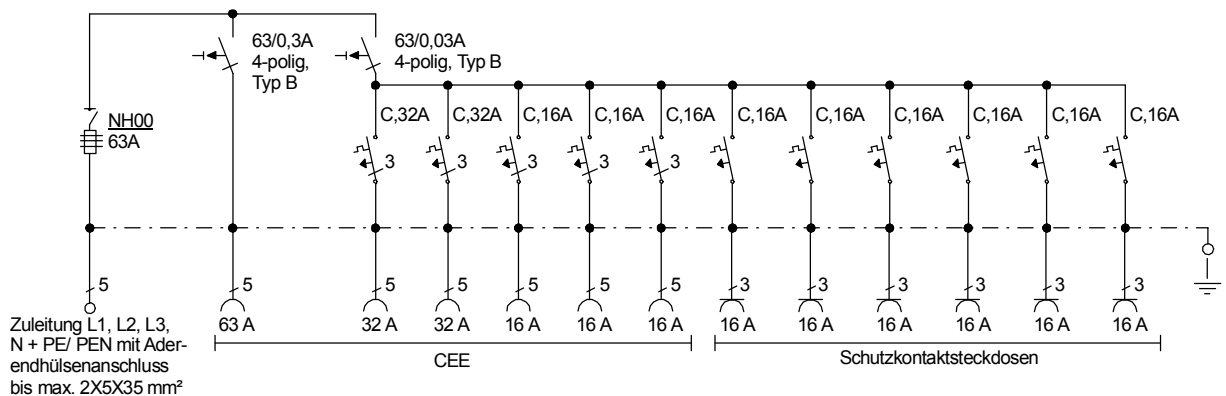

STEIDELE

Stromverteiler

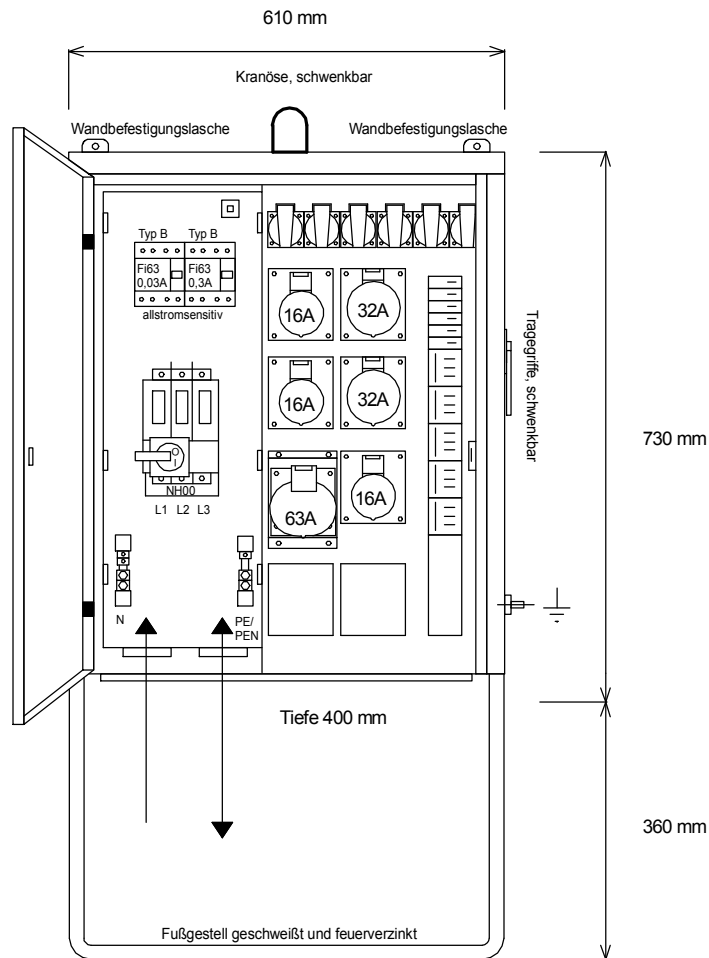
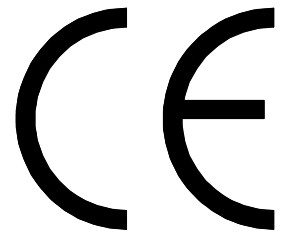

Entsprechend der neuen DIN VDE 0100-704/Okttober 2018

Typ: V 63.2/321-6

Best.Nr. 7250

Verteiler nach EN 61439-4

gezeichnet am/von:

Leistung 44 kVA, Gewicht ca. 42 kg, Gehäuse 3.1

23.03.2017 / Uffinger