

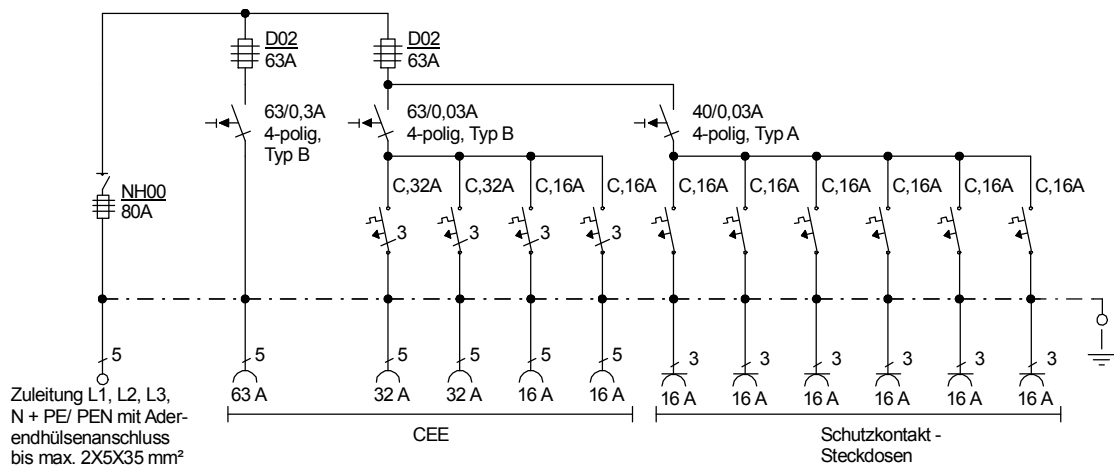

# STEIDELE

## Stromverteiler

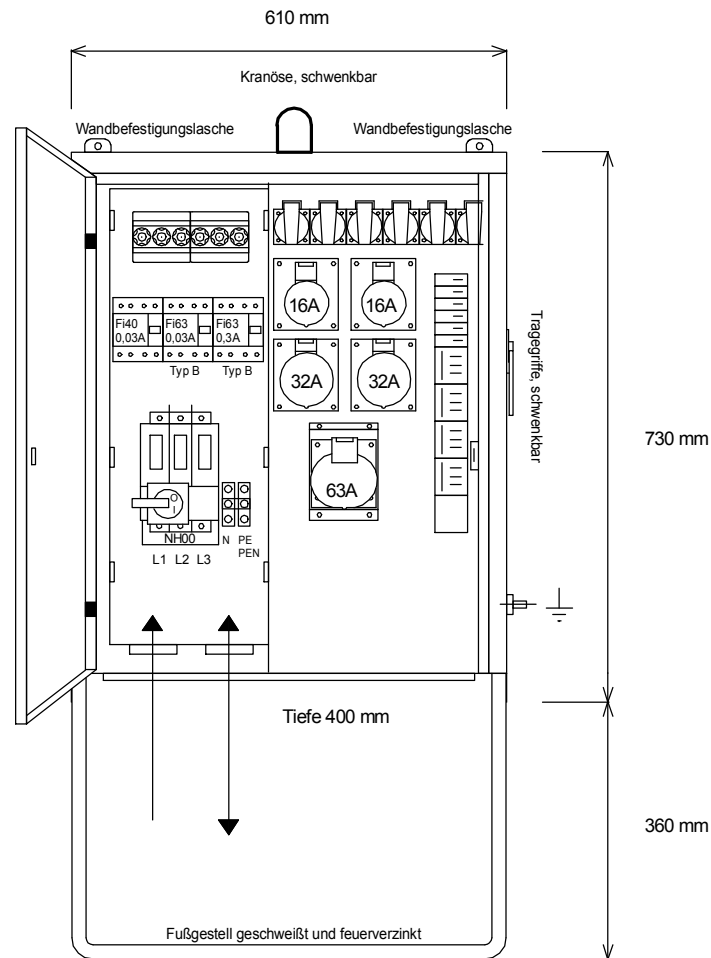

Entsprechend der neuen DIN VDE 0100-704/Okttober 2018

Typ: V 80.3/221-6

Verteiler nach EN 61439-4

Leistung 55 kVA, Gewicht ca. 47 kg, Gehäuse 3.1

Best.Nr. 7290

gezeichnet am/von:

27.03.2017 / Uffinger